

Bagger- und Schaufelzähne

COMBI[®]
parts

Verschleissteile Combi Parts[®] in hoher Qualität bürgen dafür, dass die Maschinenleistung immer optimal genutzt werden kann. Combi Parts[®] Verschleissteile tragen dazu bei, die Beanspruchung der Maschine zu optimieren. Wir liefern unseren Kunden ab Lager die ideal abgestimmten Zähne zu den Radladern und Baggern.

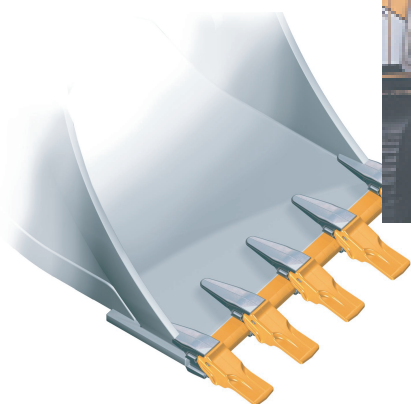

Fredi Stury AG
Schweiss- und Konstruktionswerkstätte

Riedgrabenstrasse 13 Tel. 044 - 817 19 39
CH-8153 Rümlang Fax 044 - 817 33 24
www.sturyag.ch info@sturyag.ch
Anbaugeräte für Baumaschinen



Produkteprogramm Mini / Midi

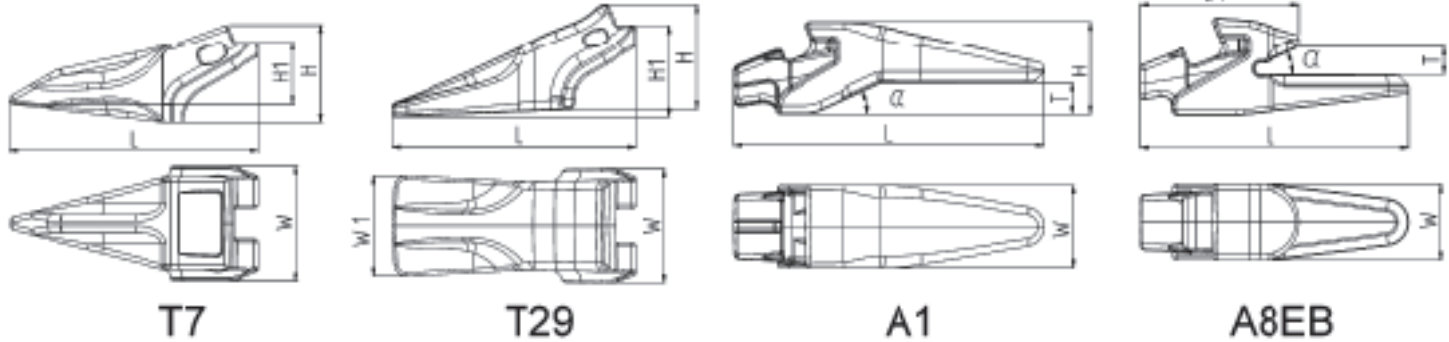

Losbrechkraft Diagramm

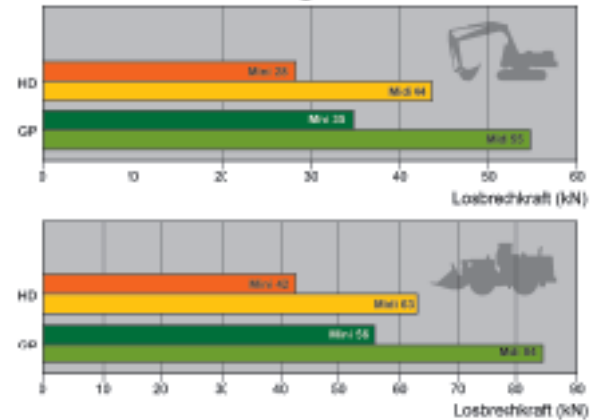

Mini 2 - 6 To.- Maschinen

Typ	Art. Nr.	Gewicht [kg]	T [mm]	α [°]	L [mm]	L1 [mm]	H [mm]	H1 [mm]	W [mm]	W1 [mm]
T7	17117	0,6	N/A	N/A	135	N/A	55	37	50	N/A
T29	17129	0,7	N/A	N/A	130	N/A	53	44	50	47
A1	17001	1,0	16 (16-20)	25	165	N/A	52	N/A	36	N/A
A8EB	17015	0,8	16 (16-20)	25	143	85	52	N/A	36	N/A
C-lock	17306	N/A	N/A	N/A	38	N/A	13,5	N/A	3,5	N/A
C-tool	17403	0,6	N/A	N/A	300	N/A	46	N/A	92	N/A

Midi 6 - 9 To.- Maschinen

Typ	Art. Nr.	Gewicht [kg]	T [mm]	α [°]	L [mm]	L1 [mm]	H [mm]	H1 [mm]	W [mm]	W1 [mm]
T7	18117	0,9	N/A	N/A	156	N/A	64	40	60	N/A
T29	18129	1,1	N/A	N/A	149	N/A	62	52	60	56
A1	18001	1,8	16 (16-20)	25	187	N/A	61	N/A	46	N/A
A8EB	18015	1,5	16 (16-20)	25	167	99	61	N/A	46	N/A
C-lock	18306	N/A	N/A	N/A	48	N/A	13,5	N/A	3,5	N/A
C-tool	17403	0,6	N/A	N/A	300	N/A	46	N/A	92	N/A



Bagger Zahnprogramm

COMBI[®] parts



Excavators

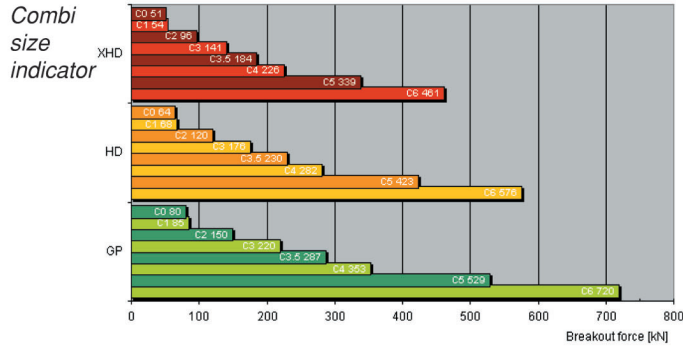

Penetration tooth T35

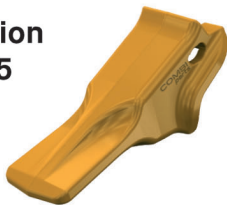

Size	Part No
T35	
C1	11 135
C2	12 135
C3	13 135
C3.5	135135
C4	14 135
C5	15 135
C6	16 135

Standard tooth T50



Size	Part No
T50	
C3.5	135150
C5	15 150
T5	
C1	11 115
C2	12 115
C3	13 115
C4	14 115
C5	15 115
C6	16 115

Standard tooth T5



Size	Part No
T58	
C3	13 158
C3.5	135158
C4	14 158
C5	15 158
C6	16 158

Abrasion tooth T58



Size	Part No
T8	
C4	14 118
C5	15 118

Abrasion tooth T8



Size	Part No
T45	
C2	12 145
C3	13 145
C3.5	135145
C4	14 145
C5	15 145

Wide flare tooth T45

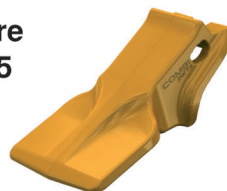

Size	Part No
T6	
C1	11 116
C2	12 116
C3	13 116
C3	13 126

Size	Part No
T7	
C2	12 117
C3	13 117
C3.5	135117
C4	14 117
C5	15 117

Size	Part No
T25	
C2	12 125
C3	13 125
C3.5	135125
C4	14 125
C5	15 125

Size	Part No	Lip thickness (mm)
A5		
C2	12 002	30
C3	13 002	40
C4	14 002	50

Size	Part No	Lip thickness (mm)
A8 Excavator		
C1	11 002	25
C2	12 007	25
C2	12 008	30
C3	13 008	40
C3	13 009	35
C3.5	135008	40
C3.5	135009	50
C4	14 008	50
C4	14 009	40
C5	15 007	70
C5	15 008	75
C5	15 009	60
C6	16 007	75
C6	16 008	90
C5R	15 010	75
C5L	15 011	75
C6C	16 010	90

Wide spade tooth T6

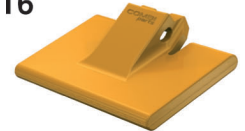

Pointed tooth T7



Twin Tiger tooth T25



A5



A8Excavator



C-lock

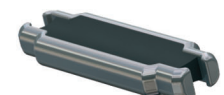



Loaders

Combi
size
indicator

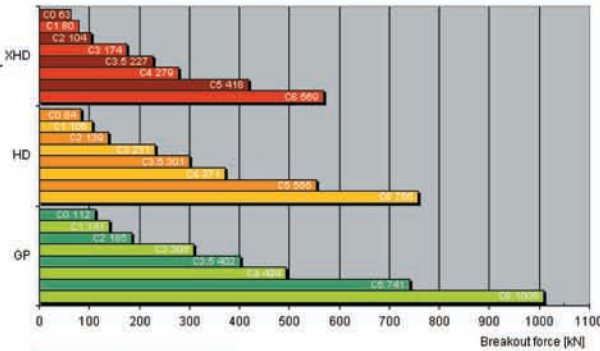

Penetration
tooth
T29



Penetration
tooth
T9

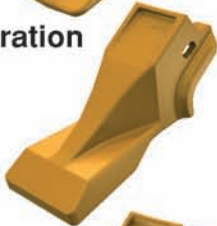

Standard
tooth
T1



Extra wide
tooth
T3



Abrasion
tooth
T2

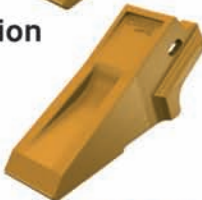

Abrasion
tooth
T8



Size	Part No
T29	
C0	10 129
C1	11 129
C2	12 129
C3	13 129
C3.5	135129
C4	14 129
C5	15 129
C6	16 129
T9	
C5	15 119
T1	
C0	10 111
C1	11 111
C2	12 111
C3	13 111
C4	14 111
T3	
C1	11 113
C2	12 113
C3	13 113
C4	14 113
T2	
C3	13 112
C5	15 112
C6	16 112
T8	
C5	15 118
T48	
C3	13 148
C3.5	135148
C4	14 148
C5	15 148
T4	
C3	13 114

Size	Part No	Lip thickness (mm)
A1		
C0	10 001	20
C1	11 001	25
C2	12 001	30
C3	13 001	40
C3.5	135001	40
C4	14 001	50
C4	14 011	40
C5	15 001	65
BA		
C2	12 052	30
C2	12 053	35
C3	13 051	35
C3	13 052	40
C4	14 052	40
A8 Loader		
C2	12 012	30
C3	13 012	40
C3	13 013	35
C3.5	135012	40
C4	14 012	40
C4	14 013	45
C5	15 006	65
C6	16 007	75
C6	16 008	90
C-lock		
Size	Part No	Dismounting tool
C0	10 306	10 403
C1	11 306	12 403
C2	12 306	12 403
C3	13 306	135403
C3.5	135306	135403
C4	14 306	135403
C5	15 316	16 403
C6	16 306	16 403

Abrasion
tooth
T48

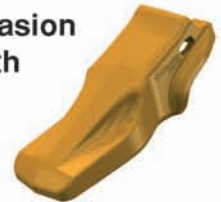

Abrasion
tooth
T4

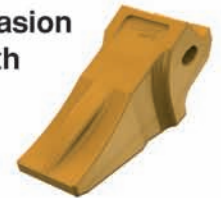

A1



BA



A8Loader



C-lock

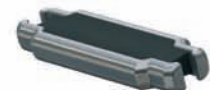

Shrouds for excavator/loader buckets

Mechanical



Bolted



COMBI[®]
parts

Welded



For best shroud recommendation, please contact your nearest Combi parts[®] dealer.



Fredy Stury AG

Schweiss- und Konstruktionswerkstätte

Riedgrabenstrasse 13 Tel. 044 - 817 19 39
CH-8153 Rümlang Fax. 044 - 817 33 24
www.sturyag.ch

Anbaugeräte für Baumaschinen